



MV7X

Podcast Microphone

Online user guide for MV7X.
Version: 1.2 (2021-J)

Table of Contents

| | | | |
|--------------------------------|----------|-----------------------|----------|
| MV7X Podcast Microphone | 3 | Windscreen | 4 |
| General Description | 3 | Specifications | 4 |
| Features | 3 | MV7X Yoke Assembly | 6 |
| The MV7X Microphone | 3 | Accessories | 7 |
| MV7X Output | 3 | Furnished Accessories | 7 |
| Mounting Instructions | 3 | Replacement Parts | 7 |
| | | Certifications | 7 |

MV7X

Podcast Microphone

General Description

The Shure MV7X is a professional-quality dynamic microphone, ideal for close mic applications that require vocal intelligibility with a balanced tone. The attractive and durable all-metal design features an adjustable yoke that can be mounted onto a variety of microphone stands for flexible placement options.

Features

Voice Isolation Technology

Highly directional cardioid pattern isolates your voice and removes unwanted background noise

Durable, Versatile Design

Rugged, all-metal construction and excellent cartridge protection for outstanding reliability

The MV7X Microphone

The MV7X features a dynamic capsule with a cardioid pattern, which uses Voice Isolation Technology to pick up sound directly in front of the microphone.

MV7X Output

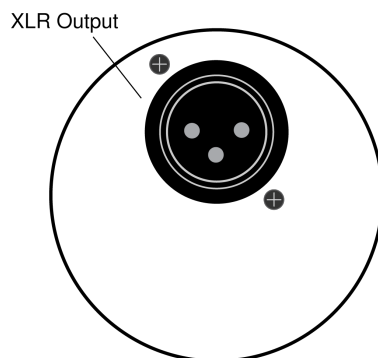

- **Passive XLR output:** Connect to XLR mixers and interfaces.

Mounting Instructions

The MV7X microphone comes equipped with a 5/8"-27 threaded mount, the thread size most commonly found on microphone stands. This mount can be used with a microphone stand or hung from a boom.

Note: Be very careful not to unloosen the screws all the way.

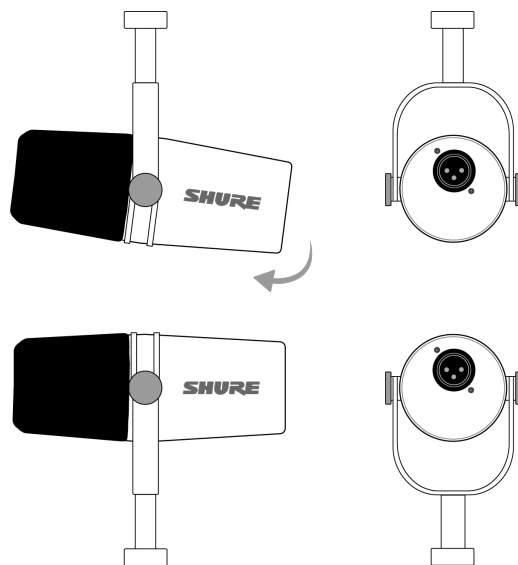

To easily flip the microphone orientation, loosen the screws and rotate 180 degrees.

Windscreen

The windscreen offers maximum protection from plosives and creates a warmer, more intimate sound for speech applications, like podcasting and gaming.

Specifications

Transducer Type

Dynamic (moving coil)

Polar Pattern

Unidirectional (Cardioid)

Output Impedance

252 Ω

Frequency Response

50 Hz to 16,000 Hz

Sensitivity

(@ 1 kHz, open circuit voltage)

-55 dBV/Pa [1] (1.78 mV)

Polarity

Positive pressure on diaphragm produces positive voltage on pin 2 with respect to pin 3

Housing

All metal construction

Mounting Type

5/8-27 thread mount

Net Weight

0.55 kg (1.21 lbs)

[1] 1 Pa=94 dB SPL

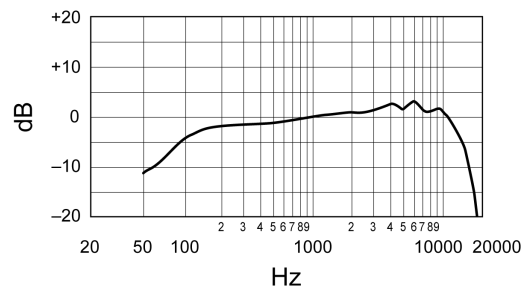

Typical Frequency Response

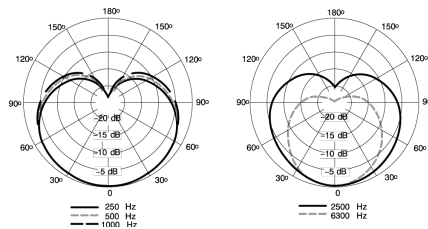

Typical Polar Pattern

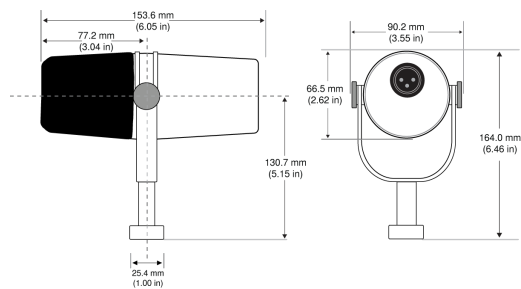

Overall Dimensions

MV7X Yoke Assembly

The MV7X yoke allows a podcaster to be flexible with mic placement. Loosen the yoke knobs and you can adjust the microphone in a variety of angles. If the microphone becomes detached from the yoke, these are the steps to put it together in the correct order to ensure that your microphone is secure. Each side uses one thin gray spring washer, one shiny silver brass washer, two black plastic washers and the yoke and threaded yoke knob.

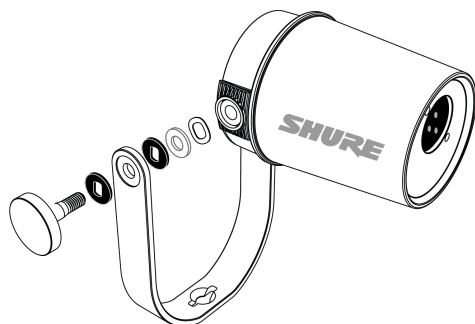

1. **Start with the threaded knob flat side down on your tabletop.**



2. **Stack the washers on the threaded knob.**
 - Place a black plastic washer on the knob.
 - Place one side of the yoke on next.
 - Then put the second black plastic washer on.
 - Place the flat silver washer and then the thin spring washer on the threaded knob.
3. **Using your finger to hold the screw assembly in place, slide the MV7X onto the threaded screw and turn the knob to keep washers in place.**

Note: Be sure to keep this side on but loose so that you have room to easily move the yoke and assemble the washers on the opposite side.

4. **On the opposite yoke arm, place the washers into the side of the MV7X in reverse order.** Thin spring washer > Flat silver washer > Black plastic washer > Yoke arm
5. **The yoke arm needs to be placed directly onto the stack of washers. To ensure that the washers are aligned, put a pen through the yoke and washers to make sure that everything is properly centered. Leave pen in place.**
6. **Place the second black plastic washer onto the remaining threaded knob.**
7. **Remove the pen. Insert the threaded knob and black plastic washer into the stacked washers and tighten both sides to ensure that your microphone is stable.**

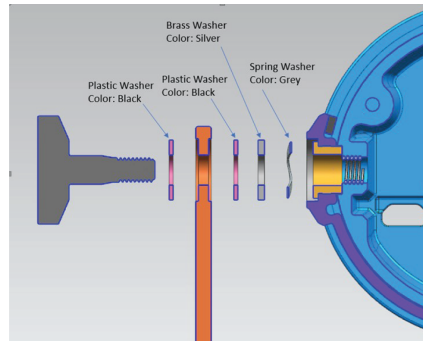

Accessories

Furnished Accessories

| | |
|----------------------|---------|
| Brass Adapter | 31B1856 |
|----------------------|---------|

Replacement Parts

| | |
|-------------------------|-----------|
| Black Windscreen | AMV7-K-WS |
|-------------------------|-----------|

Certifications

This product meets the Essential Requirements of all relevant European directives and is eligible for CE marking.